

## Distributed I/O device 8 input channels for RTD 2 wires communicating over RS-485

# DAT 3019

### FEATURES

- Modbus Server device on RS-485
- Modbus RTU/ Modbus ASCII protocol
- 8 channels 2 wires input
- Input configurable for Pt100, Pt1K, Ni100, Ni1K and resistance up to 2 K $\Omega$
- Watch-Dog Alarm
- Remotely Configurable
- 2000 Vac 3-ways Galvanic Isolation
- LED of signalling on front side for power supply and communication
- Connection by removable screw terminals
- High accuracy
- CE / UL / UKCA mark
- DIN rail mounting in compliance with EN-50022

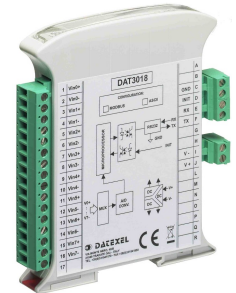

### GENERAL DESCRIPTION

The DAT 3019 device is able to acquire up to 8 analogue input signals. The data are transmitted with MODBUS RTU/MODBUS ASCII protocol on the RS-485 network (RS-232 interface is available). It is possible to connect on input 2-wires RTD sensors or up to 2 K $\Omega$  resistance sensors.

The device guarantees high accuracy and stable measure versus time and temperature.

To ensure the plant safety, it is provided a Watch-Dog timer alarm.

The isolation between the parts of circuit removes eventual ground-loop effects, allowing the use of the device even in the heavy environmental conditions.

The device is in compliance with the Directive UL 61010-1 for US market and with the Directive CSA C22.2 No 61010-1 for the Canadian market.

It is housed in a rough self-extinguishing plastic container which, thanks to its thin profile of 17.5mm only, allows a high density mounting on EN-50022 standard DIN rail.

### USER INSTRUCTIONS

Before to install the device, please read the "Installation Instruction" section.

If the module configuration is unknown, with device powered off, connect the INIT terminal to the GND terminal (ground), at the next power on the device will be auto-configured in the default settings (refer to the User Guide of the device).

Connect power supply, serial bus and analogue inputs as shown in the "Wiring" section.

The "PWR" LED state depends on the working condition of the device: see the "Light Signalling" section to verify the device working state.

To perform configuration and calibration operations, read the instructions in the User Guide of the device.

To simplify handling or replacing of the device, it is possible to remove the wired terminals even with the device powered.

### TECHNICAL SPECIFICATIONS (Typical @ 25 °C and in the nominal conditions)

INPUT			SERIAL OUTPUT		GENERAL SPECIFICATIONS	
Input Type	Min	Max	Data Transmission		Power supply voltage	10 .. 30 Vdc
<b>RTD 2 wires</b>			RS-485 asynchronous serial Baud Rate 115.2 Kbps Max. distance 1.2 Km – 4000 ft		Reverse polarity protection	60 Vdc max
Pt100	-200 °C	850 °C			<b>Max. Current consumption</b>	30 mA
Pt1000	-200 °C	200 °C			<b>ISOLATION</b>	
Ni100	-60 °C	180 °C			Among all the ways	2000 Vac, 50 Hz, 1 min
Ni1000	-60 °C	150 °C			<b>ENVIRONMENTAL CONDITIONS</b>	
<b>RES. 2 wires</b>					Operative temperature	-10°C .. +60°C
Low	0 $\Omega$	500 $\Omega$			UL Operative Temperature	-10°C .. +40°C
High	0 $\Omega$	2000 $\Omega$			Storage temperature	-40°C .. +85°C
<b>Input Accuracy (1)</b>					Humidity (not condensing)	0 .. 90 %
RTD		$\pm 0.2$ % f.s.			Maximum Altitude	2000 m slm
Resistance		$\pm 0.2$ % f.s.			Installation	Indoor
<b>Linearity (1)</b>					Category of Installation	II
RTD		$\pm 0.1$ % f.s.			Pollution Degree	2
<b>RTD excitation current</b>					<b>MECHANICAL SPECIFICATIONS</b>	
Typical		0.450 mA			Material	Self-extinguish plastic
<b>Thermal drift (1)</b>					IP Code	IP20
Full scale		$\pm 0.015$ % / °C			Wiring	wires with diameter 0.8 $\pm$ 2.1 mm <sup>2</sup> AWG 14-18
<b>Sample time</b>		0.5 $\div$ 2 sec.			Tightening Torque	0.5 N m
<b>Warm-up time</b>		3 min.			Mounting	in compliance with DIN rail standard EN-50022
					Weight	about 150 g.
					<b>CERTIFICATIONS</b>	
					<b>EMC ( for the Industrial Environments )</b>	
					Immunity	EN 61000-6-2
					Emission	EN 61000-6-4
					<b>UKCA (ref S.I. 2016 N°1091 )</b>	
					Immunity	BS EN 61000-6-2
					Emission	BS EN 61000-6-4
					<b>UL</b>	
					US Standard	UL 61010-1
					Canadian Standard	CSA C22.2 No 61010-1
					CCN	NRAQ/NRAQ7
					Typology	Open Type device
					Classification	Industrial Control Equipment
					File Number	E352854

(1) Referred to input Span (difference between max. and min. values)

## INSTALLATION INSTRUCTIONS

The device is suitable for fitting to DIN rails in the vertical position. For optimum operation and long life follow these instructions: When the devices are installed side by side it may be necessary to separate them by at least 5 mm if panel temperature exceeds 45°C and at least one of the overload conditions exist. Make sure that sufficient air flow is provided for the device avoiding to place raceways or other objects which could obstruct the ventilation slits. Moreover it is suggested to avoid that devices are mounted above appliances generating heat; their ideal place should be in the lower part of the panel. Install the device in a place without vibrations. Moreover it is suggested to avoid routing conductors near power signal cables (motors, induction ovens, inverters etc...) and to use shielded cable for connecting signals.

## CABLING

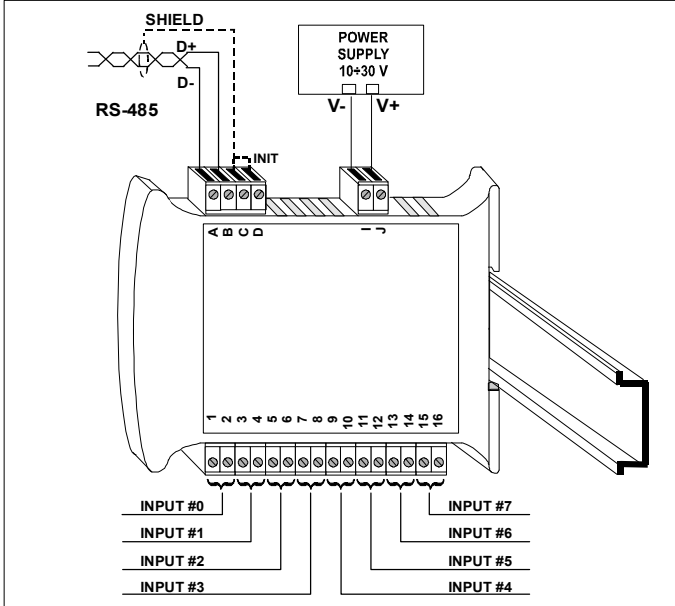

## LIGHT SIGNALLING

LED	COLOR	STATE	DESCRIPTION
PWR	GREEN	ON	Device powered
		OFF	Device not powered / Wrong RS-485 cabling.
		FAST BLINKING	Communication in progress (the blinking frequency depends to baud-rate)
		1 second BLINKING	Watch-Dog Alarm condition

## ISOLATION STRUCTURE

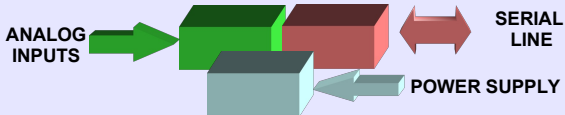

## MECHANICAL DIMENSIONS (mm)

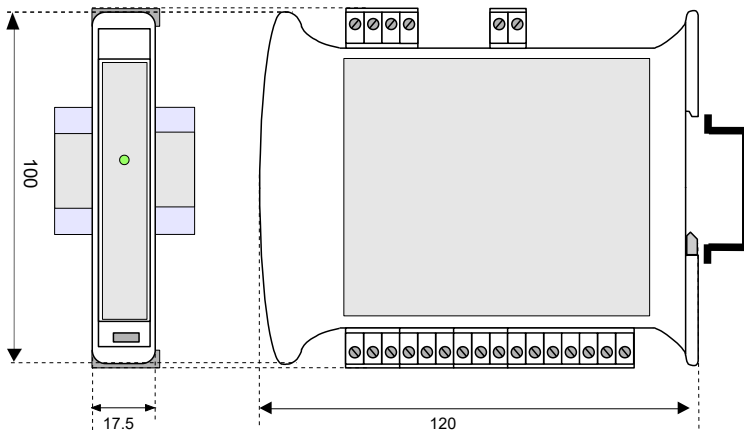

The symbol reported on the product indicates that the product itself must not be considered as a domestic waste. It must be brought to the authorized recycle plant for the recycling of electrical and electronic waste. For more information contact the proper office in the user's city, the service for the waste treatment or the supplier from which the product has been purchased.

## WIRING

### POWER SUPPLY (\*)

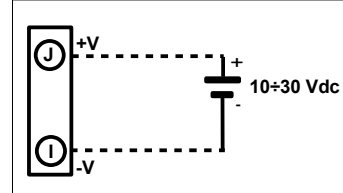

### INIT

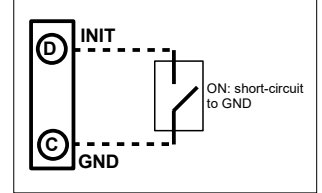

(\*) Note: for UL installation the device must be powered using a power supply unit classified NEC class 2 or SELV with limited energy

### ANALOG INPUTS

#### RTD/RES 2 WIRES

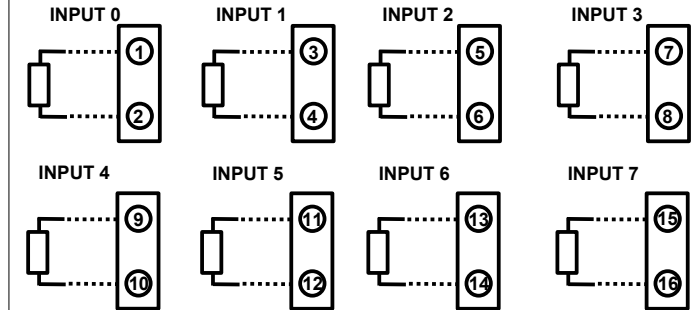

NOTE: input channels are not isolated between them.

② ④ ⑥ ⑧ ⑩ ⑫ ⑭ ⑯ = Ref.

#### RS-485

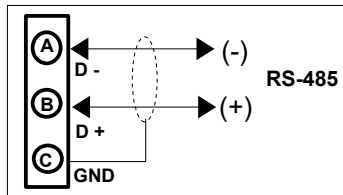

#### RS-232

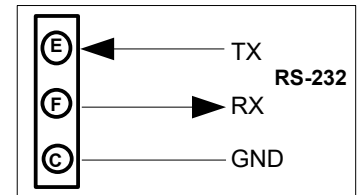

## HOW TO ORDER

In the order, it is necessary to specify the interface type (RS485 or RS232). The device can be supplied with the configuration specified by the customer.

### ORDER CODE:

DAT 3019 / **485** / **Pt100**

Interface type  
485 : RS-485  
232 : RS-232

Input type

■ = Requested  
□ = Optional